

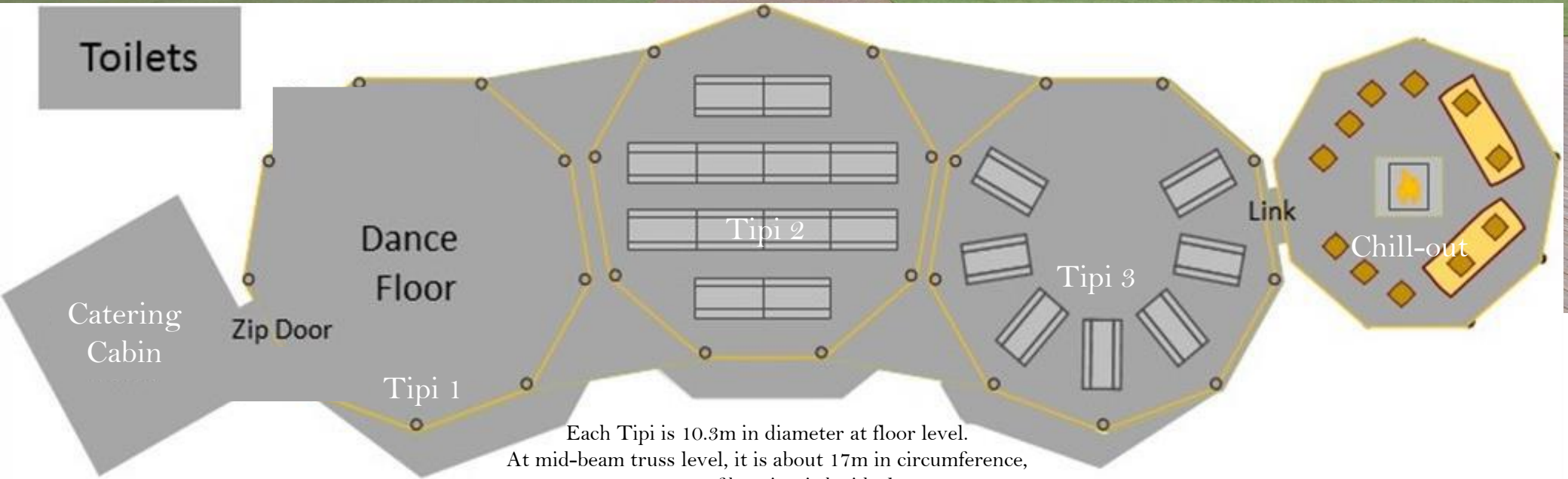

Our full inventory and measurements are listed on the following pages.

A full visual overview is provided by our 3D Virtual Tour: <https://3d.apollo3d.co.uk/hadsham-farm-weddings-arielview>

Everything you can see in the tour is included in the venue hire cost, with the **exception** of a few items from our Prop Shop which can be hired for a small additional fee – the Festival Flags, giant LOVE letters, Houseplant collection and coloured bunting. In addition, the Bell Tents are not included, but are available for your guests to hire directly from Hadsham Farm Weddings via our website.



Each Tipi is 10.3m in diameter at floor level.
At mid-beam truss level, it is about 17m in circumference,
so 20m of bunting is be ideal.



30 oak cross-back chairs

10 high chairs

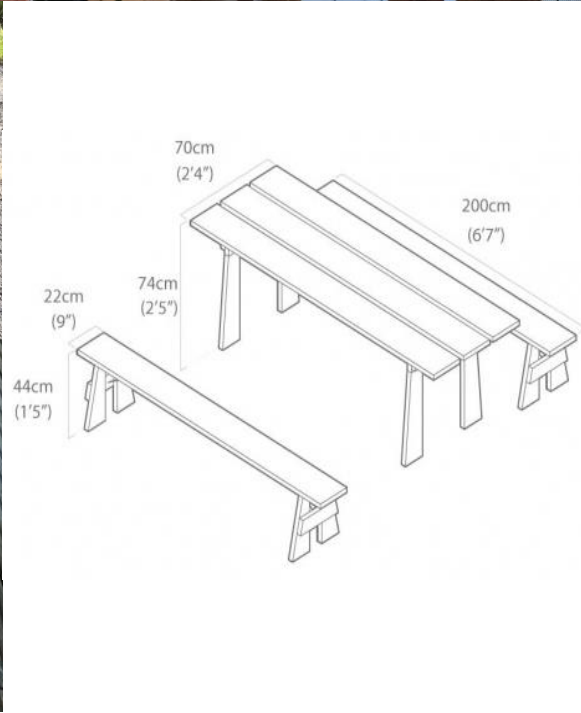

30 pine tables
Seats 6 comfortably
Or 8 if you're friendly!

Central slat 21cm wide
Or 27.5 including the filler strips

60 pine benches

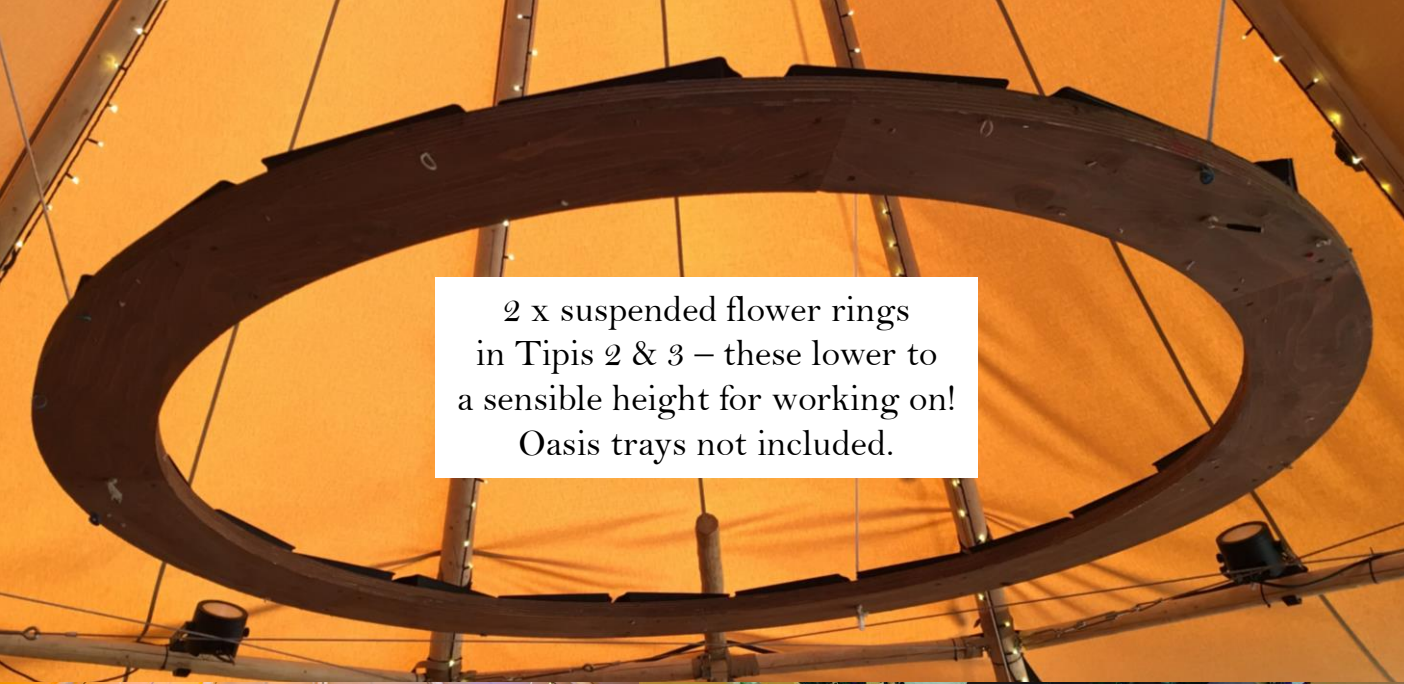

2 x suspended flower rings
in Tipis 2 & 3 – these lower to
a sensible height for working on!
Oasis trays not included.

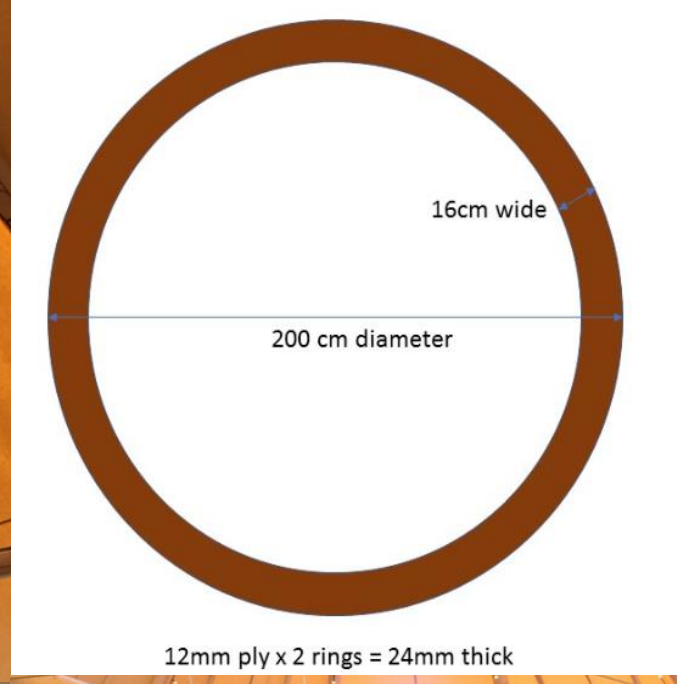



5 x oak barrels
95cm tall
53cm inside rim
diameter at the top



2 x oak barrels
with tops
118cm tall,
76cm diameter top



2 x milk
Churns
71cm tall
without lid
20.5cm inside
rim
Diameter at top



Seating & Feasting List
2018

1987	1988	1989
1990	1991	1992
1993	1994	1995
1996	1997	1998
1999	2000	
2012	2014	

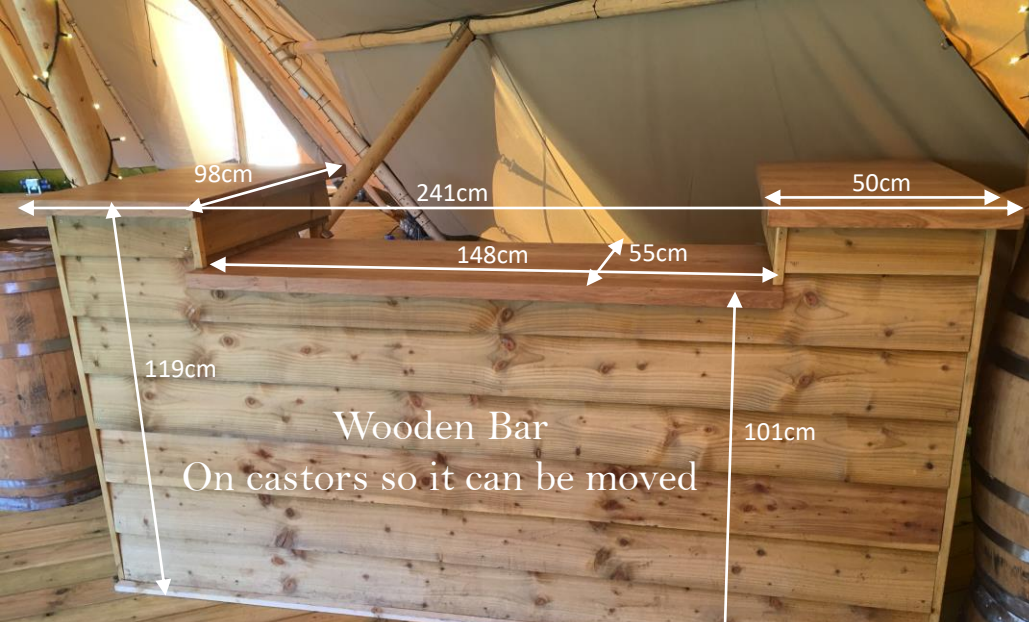

AUDIO / LIGHTING

The management at Hadsham Farm take their responsibility to the environment very seriously. This includes noise pollution resulting from events held at the venue. To minimise noise pollution, we have the following rules to meet conditions set by our local council.

ALL AMPLIFIED MUSIC MUST BE PLAYED THROUGH OUR IN-HOUSE PA SYSTEM which is installed on the edge of the dance floor in Tipi 1. Music played **OUTSIDE** must be acoustic only. The decking area is close to the Tipis so any music played through the installed sound system will be easily heard.

It is a requirement of the planning consent for the Venue that there is only 1 night of 'partying' (i.e. on the Event Day itself) and on that day **ALL AMPLIFIED MUSIC MUST BE TURNED OFF AT MIDNIGHT** - You can play low-level background music via the FBT J8 speakers outside of these time limits – i.e. on set-up day and tidy-up day. And we have a small portable PA speaker for use in the chill-out tent after midnight if required.

Our installed PA system consists of a 4 channel 4800W Powersoft amplifier powering 2x Audac VEXO 112 tops and 2x Audac BASO15 subs on the dance floor in Tipi 1.

There are additional FBT J8 reinforcement speakers throughout tipis 1,2 & 3 that can be used for speeches and background music. The amplifiers and speakers are controlled and limited by a Symetrix Prism 8x8, which is a frequency specific digital signal processor (DSP) setting the maximum volume level for visiting acts to around 95-100dB. Please note this does not cut the power to the speaker system. Visiting acts can connect to the speaker system via twin XLR leads from their own mixing desk and we have various adaptors for computer / tablet / phone connections. Also, we have an Allen & Heath ZED10 FX analogue sound mixing desk available if required.

NO VISITING AMPLIFICATION EQUIPMENT IS PERMITTED.

Bass equipment is to be DI'd (direct input/injection) into the main mix. Digital drum kits are preferred. And bands are asked to use in-ear monitoring where possible. For guitars or additional equipment, a line must be taken directly out and put into the main mix using POD type Amp Modeller / FX Units.

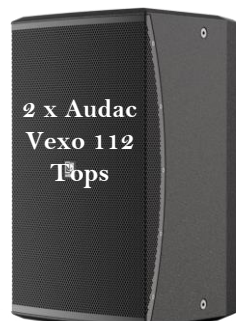
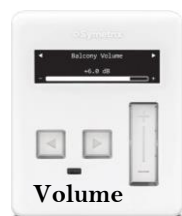
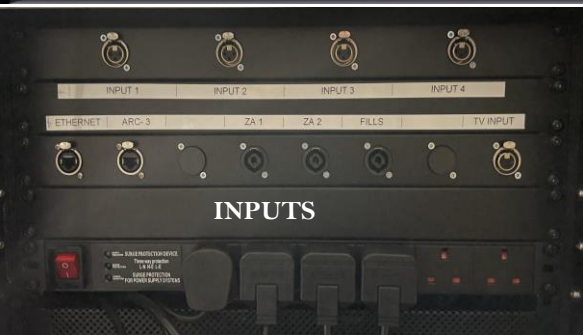

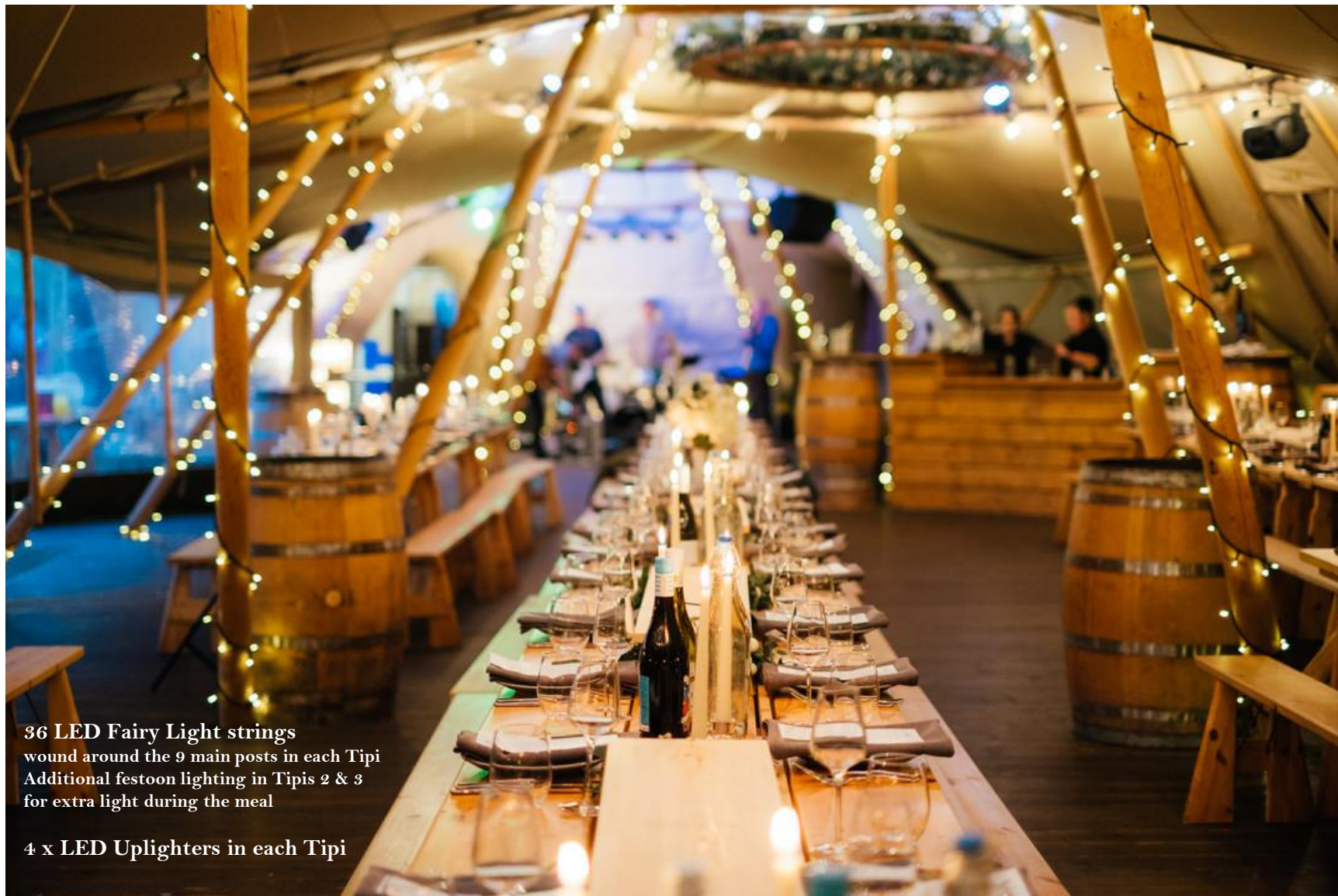

36 LED Fairy Light strings
wound around the 9 main posts in each Tipi
Additional festoon lighting in Tipis 2 & 3
for extra light during the meal

4 x LED Uplighters in each Tipi

CHILL-OUT TENT



- 2 rattan 2-seat sofas – 128x77x73cm tall
- 4 rattan armchairs – 72x77x73cm tall
- 4 rattan poufs – 45x45x45cm tall
- 2 rattan coffee tables – 103x60x36.5cm tall
- 5 all weather bean-bags – 80 diameter x 35cm tall
- 3 rugs – 195x134cm



2 x brooms
Mop, bucket and solution
2 x dustpans and brushes



40L 2.6KW
manual fill
Water boiler.
2hrs to boil
from full.



First Aid Station,
bin bags and
fire horn



Walk-in Fridge



Chest freezer
For your ice –
approx. 60kg



CATERING CABIN

6m x 6m with wooden floor
Accessed from the
Service parking area

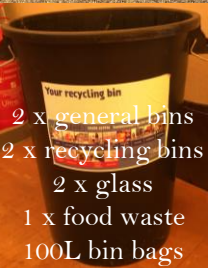

2 x general bins
2 x recycling bins
2 x glass
1 x food waste
100L bin bags



Walk-in Fridge

Regular 1.8L Kettle

Small Fridge

7 x stainless steel prep tables

—
5 on wheels, 2 fixed to the
wall by the sink



Sink with
Hot and Cold water



Window / Serving Hatch

2 x Fire extinguisher sets
CO2 and Water
One in the catering tent
One by the bar





CATERING TENT POWER

- **32amp supply, 240v – around 7kva**
Distributed via 4 x double 13a sockets
- Our system is ‘eco-friendly’ (solar / batteries, with generator back-up) and therefore, caterers, please be sparing with your use of power – try not to fire everything up at once! And wherever possible, please ‘cook’ with gas / wood / charcoal.
- **Many thanks!**

A photograph of a modern, rustic-style wooden toilet building. The building features a dark blue corrugated metal roof and light-colored horizontal wood siding. A covered walkway with a wooden railing runs along the front. Several dark blue doors are visible, some with circular icons indicating disabled access. The building is situated on a gravel base with trees in the background.

**LADIES, GENTS
& DISABLED
TOILETS**

with baby changing.
Covered decking walkway.

We supply toilet rolls,
paper towels and soap.
And bins.
And sanitary bins.
And toilet brushes.

Moon Gate Arch x 2

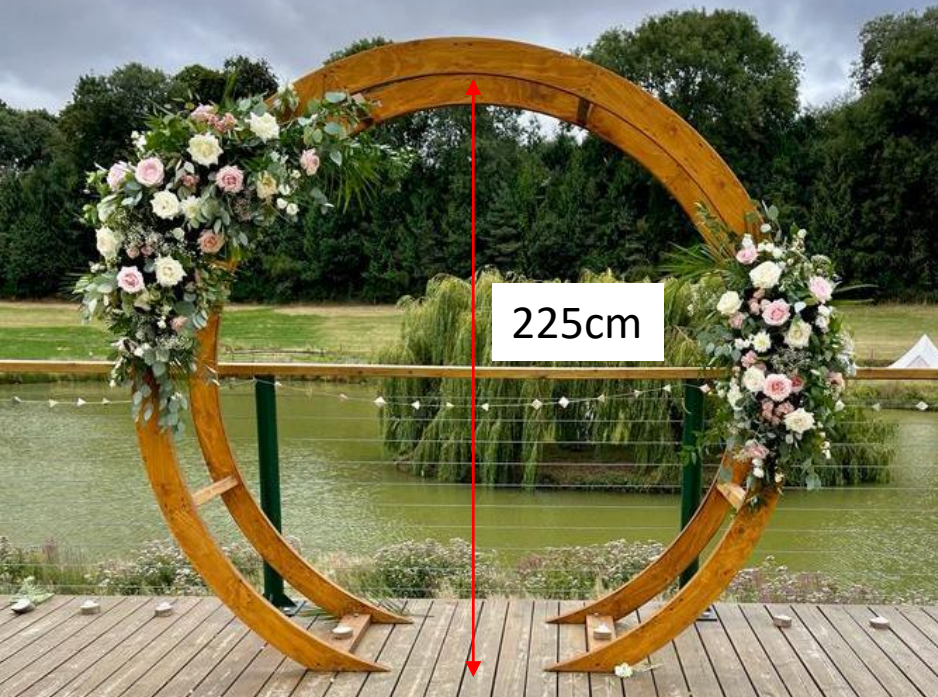

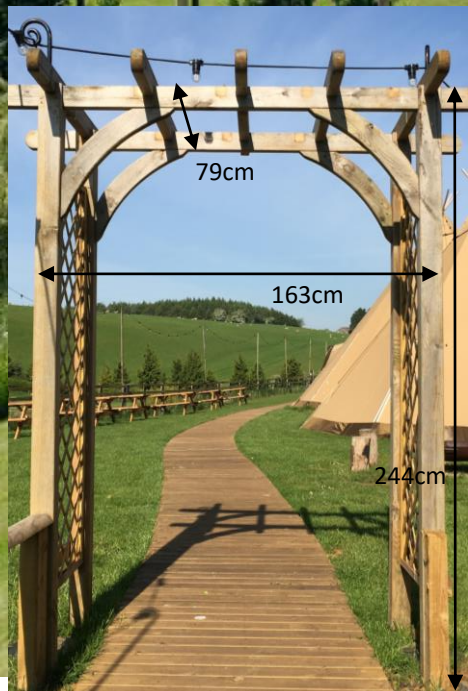

Entrance Arch
And wooden walkway
To lead you to the
Front of the Tipis

Outdoor fire-pit
We supply logs, kindling
and firelighters
You just light it!



Round Douglas Fir Picnic Tables x 4
Tabletop diameter 145cm
With 3.5m diameter parasol x 4

Rectangular Picnic Tables
x 3, on the lakeside
Tabletop 180x75 cm



Useful bits....



Carriages

Binstore →
General, Recycling
Glass, Food, Greenery

Drinking water

Ashtrays

Heater →
Diesel-fired,
Thermostat controlled

Gas BBQ for set-up day lunch?
Or a brunch the day after?



QTX QR12PA
Self-contained portable PA
unit with rechargeable
battery, twin wireless
microphones and inbuilt
USB / SD media player

For music and speeches away
From The Tipis – e.g. for a
Lakeside ceremony



1 x 12 rung step-ladder





Shower Block & Dressing Room



Wedding Suite – supplied as seen!
Kettle and Fridge. Socket for hairdryer.





FESTOON LIGHTS!
Over the Tipis,
along the car park and up to the road.
Along the front of the site, around the lake
and on the island!
All switched from the venue.

